

# Silicon Beam-Lead Schottky Barrier Mixer Diodes



DME, DMF and DMJ Series

## Features

- Ideal for MIC
- Low 1/f Noise
- Low Intermodulation Distortion
- Low Turn On
- Hermetically Sealed Packages
- SPC Controlled Wafer Fabrication

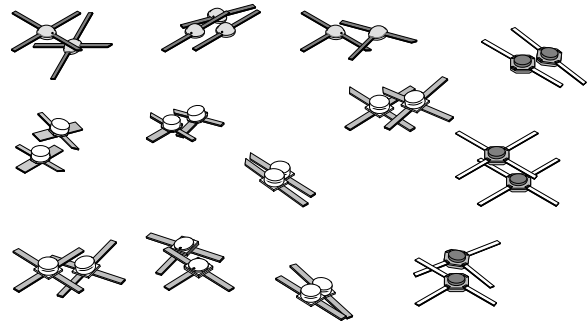

## Description

Alpha beam-lead and chip Schottky barrier mixer diodes are designed for applications through 40 GHz in Ka-band. The beam-lead design eliminates the problem of bonding to the very small junction area that is characteristic of the low capacitance involved in microwave devices.

Beam-lead Schottky barrier mixer diodes are made by the deposition of a suitable barrier metal on an epitaxial silicon substrate to form the junction. The process and choice of materials result in low series resistance along with a narrow spread of capacitance values for close impedance control.

A variety of forward knees are available, ranging from a low value for low, or starved, local oscillator drive levels to a higher value for high drive, low intermode mixer applications. The beam-lead diodes are available in a wide range of packages as shown. Capacitance ranges and series resistances are comparable with the packaged devices that are available through K-band. The unmounted diodes are especially well suited for use in microwave integrated circuits. The mounted devices can be easily inserted as hybrid elements in stripline, microstrip or other such circuitry.

Beam-lead and chip Schottky barrier diodes are categorized by noise figure for mixer applications in four frequency ranges: S, X, Ku and Ka-bands. However, they can also be used as modulators, high speed switches and low power limiters.

Several types of semiconductor-barrier metal systems are available, thus allowing proper selection for optimum mixer design. For most applications the N-type silicon, low drive types are preferable, especially for starved LO mixers.

Beam-lead diodes are ideally suited for balanced mixers, since they exhibit low parasitics and are extremely uniform. A typical  $V_F$  vs.  $I_F$  curve is shown in Figure 1. Typical noise figures vs LO drive is shown in Figure 2 for single N-type, low drive diode types.

## Maximum Ratings

Storage Temperature:	-65°C/+175°C
Operating Temperature:	-65°C/+175°C
Dissipated Power:	75 mW/Junction
Max Current:	100 mA

Band	Frequencies
S	2 to 4
C	4 to 8
X	8.2 to 12.4
Ku	12.4 to 18.0

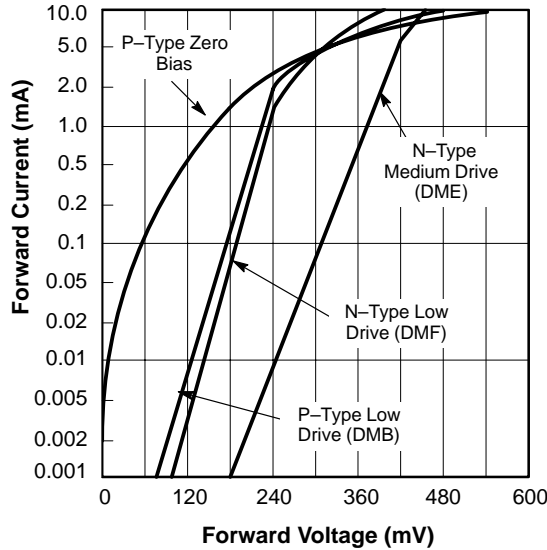

Figure 1. Typical Forward DC Characteristics Curves – Voltage vs. Current

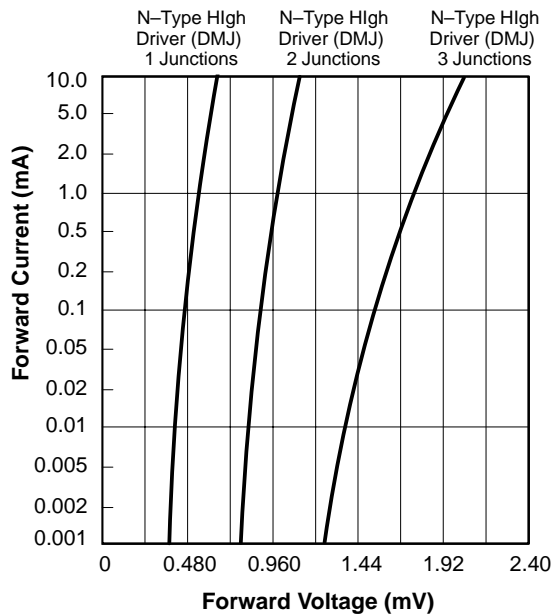

Figure 2. Typical Forward DC Characteristic Curves – Voltage vs. Current

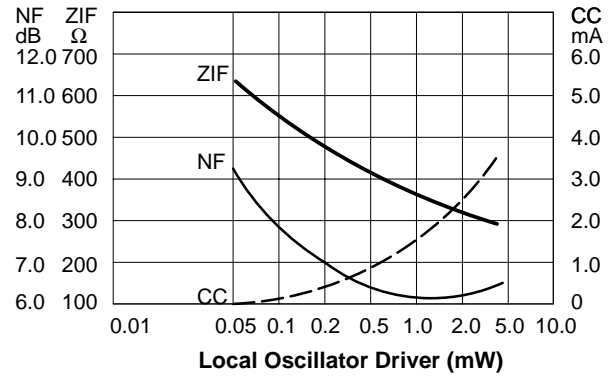
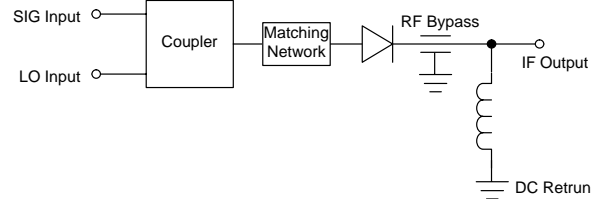
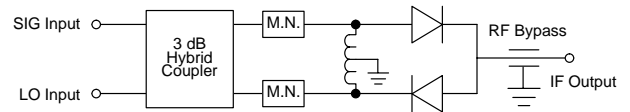

Figure 3. Typical X-Band Low Drive Mixer Diode – RF Parameters vs. Local Oscillator Drive

Single Ended Mixer



Balanced Mixer



Double Balanced Mixer

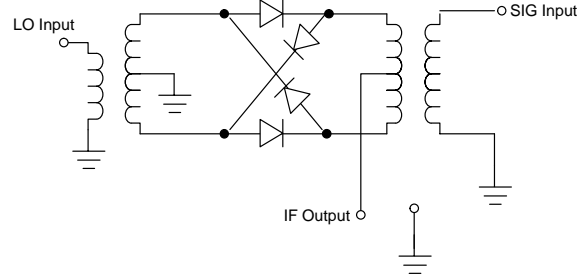
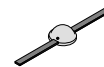

Figure 4. Typical Mixer Circuits

Ordering Information

To order a packaged diode, simply append the part number to the package outline number. For example, a Medium Drive Ring Quad, Ku band (part number DME2859-000) in a 234 package would be ordered as DME2859-234.

### Beam-Lead (Singles), N-Type, Low, Medium, High Drive



Freq. Band	C <sub>J</sub> 0V 1 MHz pF		R <sub>S</sub> 5 mA Ω	V <sub>B</sub> 10 μA Ω	V <sub>F</sub> 1 mA mV		Drive Level	Beam Lead	Epoxy Packages	
	Min.	Max.	Max.	Min.	Min.	Max.		491-011	250	230
<b>S</b>	0.30	0.50	5	2	200	260	Low	DMF2820-000	DMF2820-250	
				3	300	400	Med	DME2127-000	DME2127-250	
				4	500	600	High	DMJ2823-000	DMJ2823-250	
<b>X</b>	0.15	0.30	8	2	250	310	Low	DMF2821-000	DMF2821-250	
				3	325	425	Med	DME2957-000	DME2957-250	
				4	550	650	High	DMJ2777-000	DMJ2777-250	
<b>KU</b>	0.05	0.15	13	2	260	330	Low	DMF2344-000	DMF2344-250	DMF2344-230
				3	350	450	Med	DME2333-000	DME2333-250	DME2333-230
				4	500	680	High	DMJ2824-000	DMJ2824-250	DMJ2824-230
<b>K</b>	-	0.1	18	2	270	350	Low	DMF2822-000		DMF2822-230
				3	375	550	Med	DME2458-000		DME2458-230
				4	600	700	High	DMJ2825-000		DMJ2825-230

### Beam-Lead (Series Pair), N-Type, Low, Medium, High Drive

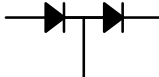

Freq. Band	C <sub>J</sub> 0V 1 MHz pF		R <sub>S</sub> 10 mA Ω	V <sub>B</sub> 10 μA Ω	V <sub>F</sub> 1 mA mV		Drive Level	Beam Lead	Epoxy Packages	
	Min.	Max.	Max.	Min.	Min.	Max.		504-012	252	232
<b>S</b>	0.30	0.50	5	2	200	260	Low	DMF2835-000	DMF2835-252	
				3	300	400	Med	DME2050-000	DME2050-252	
				4	500	600	High	DMJ2092-000	DMJ2092-252	
<b>X</b>	0.15	0.30	8	2	250	310	Low	DMF2826-000	DMF2826-252	
				3	325	425	Med	DME2829-000	DME2829-252	
				4	550	650	High	DMJ2093-000	DMJ2093-252	
<b>KU</b>	0.05	0.15	13	2	260	330	Low	DMF2827-000	DMF2827-252	DMF2827-232
				3	350	450	Med	DME2830-000	DME2830-252	DME2830-232
				4	500	680	High	DMJ2832-000	DMJ2832-252	DMJ2832-232
<b>K</b>	-	0.1	18	2	270	350	Low	DMF2828-000		DMF2828-232
				3	375	550	Med	DME2831-000		DME2831-232
				4	600	700	High	DMJ2833-000		DMJ2833-232

### Beam-Lead (Common Cathode), N-Type, Low, Medium, High Drive

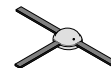
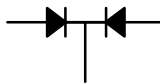

Freq. Band	C <sub>J</sub> 0V 1 MHz pF		R <sub>S</sub> 10 mA Ω	V <sub>B</sub> 10 μA Ω	V <sub>F</sub> 1 mA mV		Drive Level	Beam Lead	Epoxy Package
	Min.	Max.	Max.	Min.	Min.	Max.		504-013	253
S	0.30	0.50	5	2	200	260	Low	DMF2182-000	DMF2182-253
				3	300	400	Med	DME2205-000	
				4	500	600	High	DMJ2208-000	DMJ2208-253
X	0.15	0.30	8	2	250	310	Low	DMF2183-000	DMF2183-253
				3	325	425	Med	DME2206-000	
				4	550	650	High	DMJ2209-000	
KU	0.05	0.15	13	2	260	330	Low	DMF2184-000	DMF2184-253
				3	350	450	Med	DME2207-000	
				4	500	680	High	DMJ2210-000	
K	-	0.1	18	2	270	350	Low	DMF2834-000	
				3	375	550	Med	DME2835-000	
				4	600	700	High	DMJ2836-000	

### Beam-Lead (Anti-Parallel Pairs), N-Type, Low, Medium, High Drive

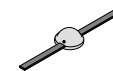
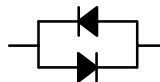

Freq. Band	C <sub>J</sub> 0V 1 MHz pF		R <sub>S</sub> 10 mA Ω	V <sub>B</sub> 10 μA Ω	V <sub>F</sub> 1 mA mV		Drive Level	Beam Lead	Epoxy Package
	Min.	Max.	Max.	Min.	Min.	Max.		522-025	251
S	0.30	0.50	5	2	200	260	Low	DMF2185-000	DMF2185-251
				3	300	400	Med	DME2282-000	DME2282-251
				4	500	600	High	DMJ2303-000	DMJ2303-251
X	0.15	0.30	8	2	250	310	Low	DMF2186-000	DMF2186-251
				3	325	425	Med	DME2283-000	DME2283-251
				4	550	650	High	DMJ2304-000	DMJ2304-251
KU	0.05	0.15	13	2	260	330	Low	DMF2187-000	DMF2187-251
				3	350	450	Med	DME2284-000	DME2284-251
				4	500	680	High	DMJ2246-000	DMJ2246-251
K	-	0.1	18	2	270	350	Low	DMF2837-000	
				3	375	550	Med	DME2838-000	
				4	600	700	High	DMJ2839-000	

### Beam-Lead (Ring Quad), N-Type, Low, Medium, High Drive

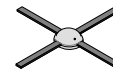
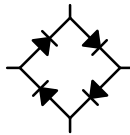

Freq. Band	C <sub>J</sub> 0V 1 MHz pF		R <sub>S</sub> 10 mA Ω	V <sub>B</sub> 10 μA Ω	V <sub>F</sub> 1 mA mV		Drive Level	Beam Lead	Epoxy Packages	
	Min.	Max.	Max.	Min.	Min.	Max.		488-002	254	234
<b>S</b>	0.30	0.50	5	2	200	260	Low	DMF2865-000	DMF2865-254	DMF2865-234
				3	300	400	Med	DME2857-000	DME2857-254	DME2857-234
				4	500	600	High	DMJ2502-000	DMJ2502-254	
<b>X</b>	0.15	0.30	8	2	250	310	Low	DMF2011-000	DMF2011-254	DMF2011-234
				3	325	425	Med	DME2858-000	DME2858-254	
				4	550	650	High	DMJ2990-000	DMJ2990-254	
<b>KU</b>	0.05	0.15	13	2	260	330	Low	DMF2012-000	DMF2012-254	DMF2012-234
				3	350	450	Med	DME2859-000	DME2859-254	DME2859-234
				4	500	680	High	DMJ2667-000	DMJ2667-254	DMJ2667-234
<b>K</b>	-	0.1	18	2	270	350	Low	DMF2454-000		DMF2454-234
				3	375	550	Med	DME2459-000		DME2459-234
				4	600	700	High	DMJ2455-000		DMJ2455-234

### Beam-Lead (Bridge Quad), N-Type, Low, Medium, High Drive

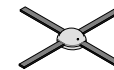
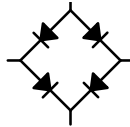

Freq. Band	C <sub>J</sub> 0V 1 MHz pF		R <sub>S</sub> 10 mA Ω	V <sub>B</sub> 10 μA Ω	V <sub>F</sub> 1 mA mV		Drive Level	Beam Lead	Epoxy Package	
	Min.	Max.	Max.	Min.	Min.	Max.		488-004	255	235
<b>S</b>	0.30	0.50	5	2	200	260	Low	DMF2076-000	DMF2076-255	DMF2076-235
				3	300	400	Med	DME2029-000	DME2029-255	
				4	500	600	High	DMJ2312-000	DMJ2312-255	
<b>X</b>	0.15	0.30	8	2	250	310	Low	DMF2077-000	DMF2077-255	
				3	325	425	Med	DME2850-000	DME2850-255	
				4	550	650	High	DMJ2088-000	DMJ2088-255	
<b>KU</b>	0.05	0.15	13	2	260	330	Low	DMF2078-000	DMF2078-255	
				3	350	450	Med	DME2031-000	DME2031-255	
				4	500	680	High	DMJ2768-000	DMJ2768-255	
<b>K</b>	-	0.1	18	2	270	350	Low	DMF2848-000		
				3	375	550	Med	DME2851-000		
				4	600	700	High	DMJ2852-000		

### Beam-Lead (Star Quad), N-Type, Low, Medium, High Drive

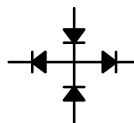

Freq. Band	C <sub>J</sub> 0V 1 MHz pF		R <sub>S</sub> 10 mA Ω	V <sub>B</sub> 10 μA Ω	V <sub>F</sub> 1 mA mV		Drive Level	Beam Lead
	Min.	Max.	Max.	Min.	Min.	Max.		520-034
S	0.30	0.50	5	2	200	260	Low	DMF2137-000
				3	300	400	Med	DME2191-000
				4	500	600	High	DMJ2193-000
X	0.15	0.30	8	2	250	310	Low	DMF2138-000
				3	325	425	Med	DME2192-000
				4	550	650	High	DMJ2194-000
KU	0.05	0.15	13	2	260	330	Low	DMF2189-000
				3	350	450	Med	DME2178-000
				4	500	680	High	DMJ2195-000
K	-	0.1	18	2	270	350	Low	DMF2190-000
				3	375	550	Med	DME2174-000
				4	600	700	High	DMJ2180-000

### Beam-Lead (Octo Quad Ring), N-Type, Medium, High Drive

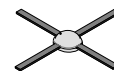

Freq. Band	C <sub>J</sub> 0V 1 MHz pF		R <sub>S</sub> 5mA Ω	V <sub>B</sub> 10 μA Ω	V <sub>F</sub> 1 mA mV		Drive Level	Beam Lead	Epoxy
	Min.	Max.	Max.	Min.	Min.	Max.		294-020	257
S-X	0.15	0.30	10	6	600	800	Med	DME3273-000	DME3273-257
				8	1000	1200	High	DMJ4759-000	DMJ4759-257
KU	0.05	0.15	16	6	650	850	Med	DME3274-000	DME3274-257
				8	1100	1300	High	DMJ4771-000	DMJ4771-257

## Outline Drawings

### 484-004

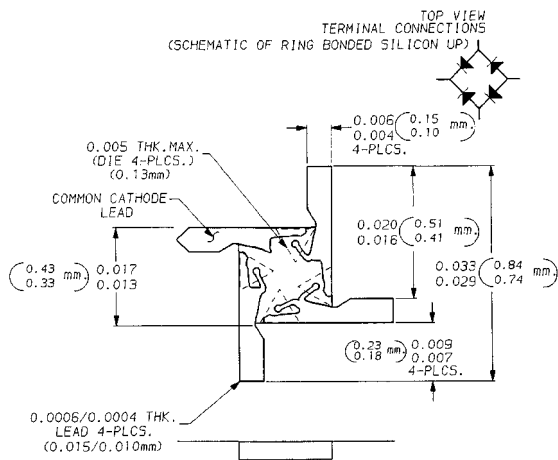

### 491-011

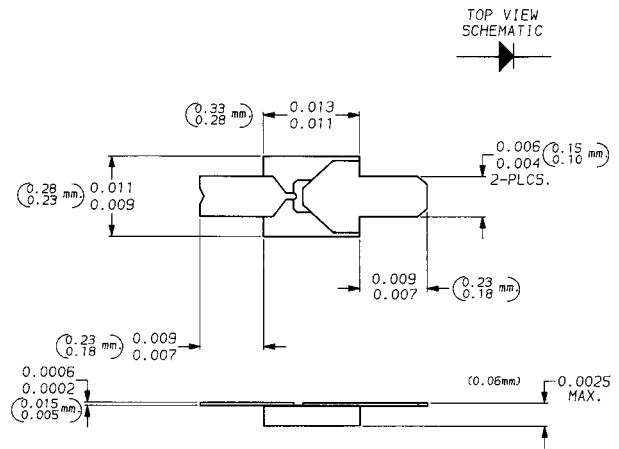

### 488-002

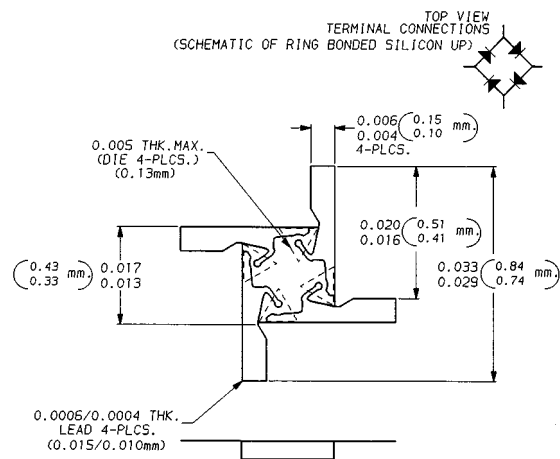

### 504-012

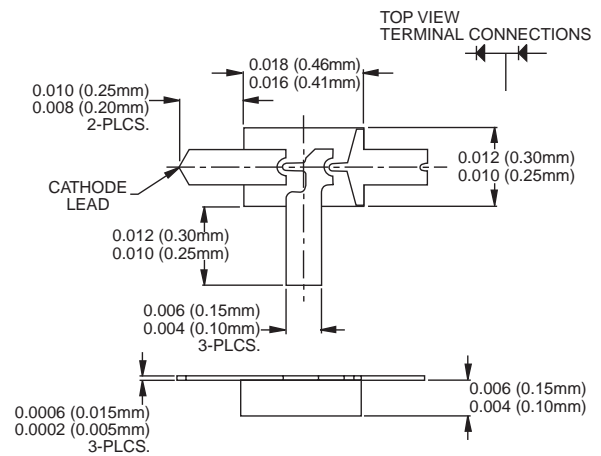

504-013

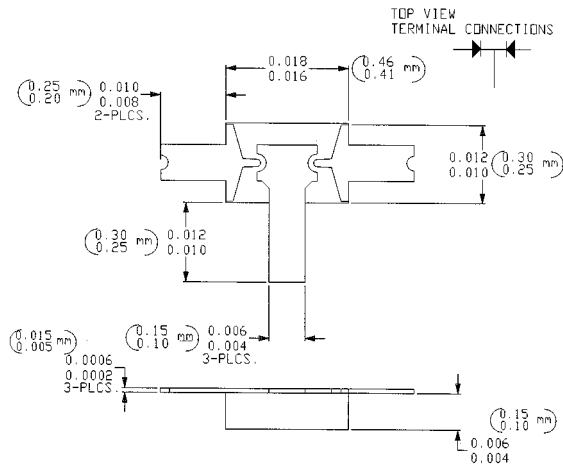

522-025

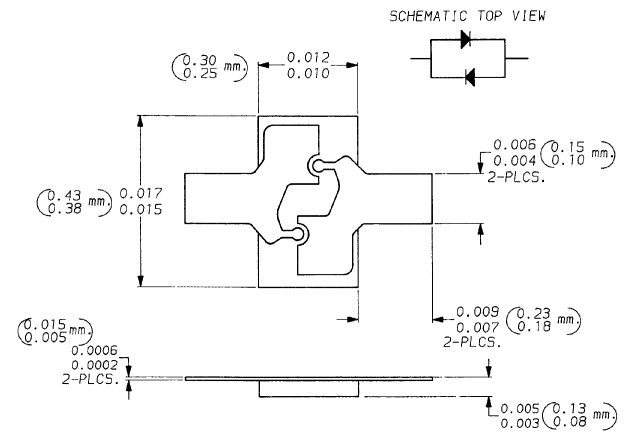

520-034

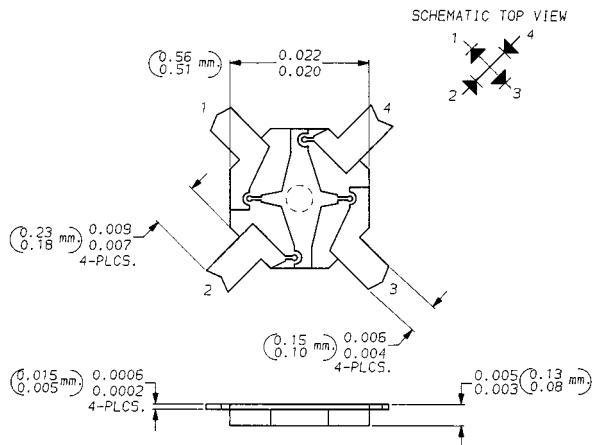

3